



SERIES AK 40, 45 & 46

3/8 INCH DIAPHRAGM VALVE

Packless – manual and pneumatic (NC & NO)

- Compression tube fitting, NPT and BSPT connections available
- Field repairable
- SS 316L construction
- Operating pressure from 125 psig (9 bar) to 3,000 psig (207 bar)
- Machined from bar stock
- Lock Out / Tag Out (LOTO) options
- Flow capacity 0.5 C_v
- Constant bleed option 5, 8 and 15 slpm of N₂ @ 80 psig (5.5 bar) refer to PN 430
- Cleaned for O₂ service
- Internal manual knob stop prevents overstressing seat
- All metal seals to atmosphere
- Two step pneumatic valve option: dual operation – metered or full open
- Installation and operating instructions available at www.aptech-online.com in the Tech Briefs section

Manual valves

	PSIG / BAR		
	250 / 17	300 / 21	3,000 / 207
AK 4600 – Round knob, multi-turn		●	○
AK 4625 – Lever valve, 1/4 turn – LOTO, PL 225 optional – Lever position indicates valve status		●	○
AK 4650 – Round knob, 1/4 turn – Open/closed status indication window – Switch option for remote monitoring		●	○
AK 4652 – Round knob, 1/4 turn – Open/closed status indication window – Unique design combines scalloped round knob with raised rectangular section	●		
AK 4657 and 4659 – Round knob, 1/4 turn – Pull, then turn to open – operational safety feature – Open/closed status indication window – LOTO – integral standard feature	●	●	○

Pneumatic valves, normally closed (NC)

	PSIG / BAR		
	125 / 9	300 / 21	3,000 / 207
AK 4000 – Switch option for remote monitoring			●
AK 4540	●		
AK 4542	●		
AK 4550 – Switch option for remote monitoring		●	
AK 4571 – Dual mode – metered or full open	●		

Pneumatic valve, normally open (NO)

	PSIG / BAR	
	250 / 17	
AK 4580 – Switch option for remote monitoring	●	

All specifications subject to change without notice.

● = Standard ○ = Optional

HIGH PURITY ~ HIGH VALUE

Engineering Data — Manual valves

Operating pressure	AK 4600, 4625, 4650, 4657 AK 4652, 4659	Vacuum to 300 psig (21 bar); HR option 3,000 psig (207 bar) Vacuum to 250 psig (17 bar)
Flow coefficient (C _v)	AK 4600, 4625, 4650, 4652 AK 4657, 4659	0.5 (X _T = 0.6)

Engineering Data — Pneumatic valves

Operating pressure	AK 4540, 4542, 4571 AK 4580 AK 4550 AK 4000	Vacuum to 125 psig (9 bar) Vacuum to 250 psig (17 bar) Vacuum to 300 psig (21 bar) Vacuum to 3,000 psig (207 bar)
Flow coefficient (C _v)	AK 4540, 4550, 4571, 4580 AK 4000	0.5 (X _T = 0.6) 0.35 (X _T = 0.6)
Status	AK 4000, 4540, 4550, 4552, AK 4571 AK 4580	Normally closed (NC) Normally open (NO)
Actuation pressure	AK 4540, 4550, 4571, 4580 AK 4542	70 to 110 psig (5 to 8 bar) 60 to 110 psig (4 to 8 bar)
Actuation port	AK 4000, 4540, 4580 AK 4542 AK 4550, 4571	1/8 NPT, top port M5, top port M5, side port

Engineering Data — Other parameters all valves

Inlet and outlet connectors	3/8 inch compression, NPT or BSPT
Internal volume	0.12 in ³ (2.14 cm ³)
Operating temperature	-40° to +160° F (-40° to 71° C)*
Proof pressure	150% of operating pressures
Burst pressure	300% of operating pressures
Leak rate	1 x 10 ⁻⁹ sccs

Engineering Data — Wetted materials all valves

Body	SS 316L
Diaphragm	Ni-CO alloy / UNS R30003
Seat	PCTFE (Polyimide optional)

AK 4571 — Metered flow range tolerance at 80 psig N₂ inlet, 0 psig outlet

10 to 20 slpm	+/- 6 slpm
21 to 50 slpm	+/- 10 slpm
51 to 100 slpm	+/- 15 slpm
101 to 200 slpm	+/- 20 slpm
201 to 350 slpm (AK 4571 only)	+/- 25 slpm

*VS option 14° to 194°F (-10° to + 90°C).

All specifications subject to change without notice.

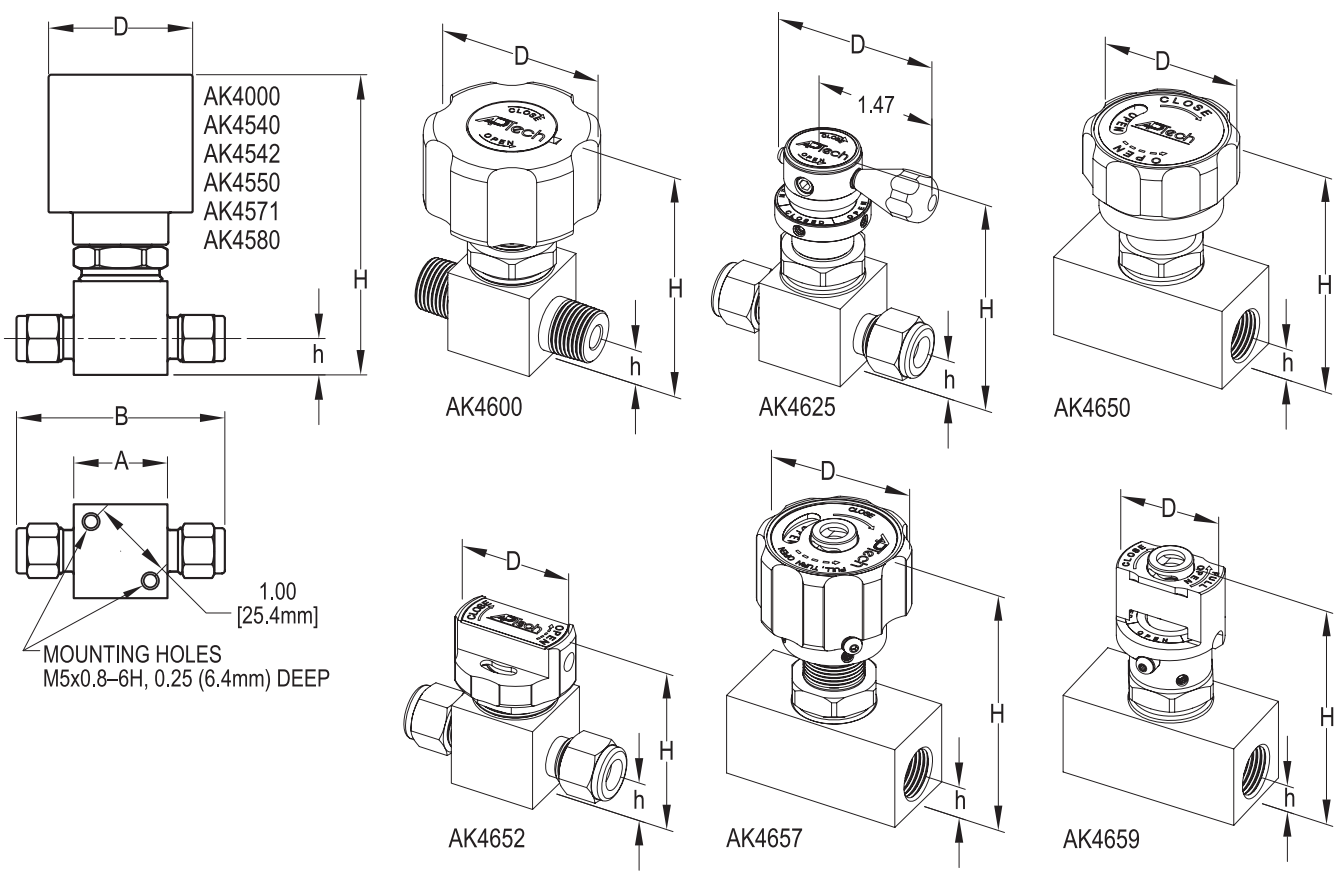

VALVE	D		H	
	inch	mm	inch	mm
AK4000	ø1.98	50.3	~4.10	104
AK4540	ø1.46	37.1	~3.49	89
AK4542	ø1.57	40.0	~2.24	57
AK4550	ø1.37	34.8	~3.28	83
AK4571	ø1.72	43.7	~3.63	92
AK4580	ø1.46	37.1	~3.17	81
AK4600	ø2.12	53.8	~3.00	76
AK4625	2.04	51.8	~2.94	75
AK4650	ø1.87	47.5	~3.02	77
AK4652	ø1.50	38.1	~2.17	55
AK4657	ø1.87	47.5	~3.60	91
AK4659	ø1.30	33.0	~3.13	80

- All manual valves are shown in open position.
- All dimensions in inches (mm).
- Metric dimensions are for reference only.
- All specifications subject to change without notice.

CONNECTION	A		B		h	
	inch	mm	inch	mm	inch	mm
6Tx6T	1.12 SQ	28.4	2.68	68.1	0.44	11.2
6Nx6N	1.12 SQ	28.4	2.32	58.9	0.44	11.2
6BRNx6BRN	1.12 SQ	28.4	2.32	58.9	0.44	11.2
6x6	N/A	N/A	2.32	58.9	0.44	11.2
6BRx6BR	N/A	N/A	2.32	58.9	0.44	11.2

HIGH PURITY – HIGH RELIABILITY

- High leak integrity – all metal seals to atmosphere
- Replaceable seat
- Designed for high purity specialty gas applications
- Rugged reliability from a company known for customer service

Value status indicating switch options

Pneumatic valve

ISC: NC switch AK 4550 & 4580

ISO: NO switch AK 4550 & 4580

Manual valve

ISH: switch AK 4650

Please refer to the Installation and Operating Instructions for further information regarding switches.

AK 4625 handle options

Handle color options

RD = Red

WT = White

BL = Blue

GR = Green

Black (standard)

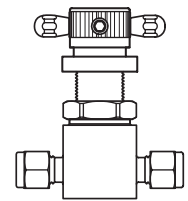
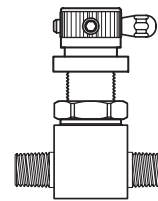
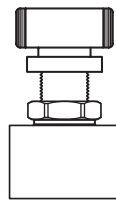
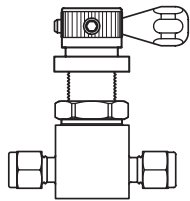
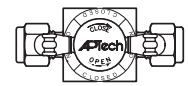
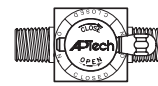
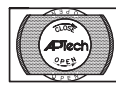

STANDARD

LT*

BB*

TN

*LT and BB handle options limit valve operating pressure to 250 psig (17 bar)

CAUTION: Product selection is the sole responsibility of the user, regardless of any recommendations or suggestions made by the factory. The user shall make selections based upon their own analysis and testing with regard to function, material compatibility and product ratings. Proper installation, operation and maintenance are also required to assure safe, trouble free performance.

Sample Order Number

AK 4652S 2P 6T 6T

AK 4652 | Series

AK 4540, 4542, 4550
AK 4000, 4580
AK 4600, 4625
AK 4650, 4652, 4657, 4659

S | Material

S = Stainless steel (SS)

2P | Ports

2P = 2 ports

6T 6T | Connections
Inlet / Outlet

6 = 3/8 inch NPT female
6N = 3/8 inch NPT male
6T = 3/8 inch compression
6BR = 3/8 inch BSPT female
6BRN = 3/8 inch BSPT male

Inlet and outlet connections must be the same.

Options

VS = Polyimide Seat
P = Panel mount, manual valves*
(except 4652)
IS = Indicating switch* (AK 4000 only)
ISC = NC switch 4550 & 4580*
ISO = NO switch 4550 & 4580*
ISH = Switch 4650*
HR** = Higher inlet pressure
RD = Red 4625 lever
WT = White 4625 lever
BL = Blue 4625 lever
GR = Green 4625 lever
LT = 4625 handle option
BB = 4625 handle option
TN = 4625 handle option
MXXX‡ = 4571 metered adjusts flow in slpm
at 80 psig N₂

*Refer to manual for installation information.

**HR only available with AK4600, 4625, 4650 and 4657.

‡NOTE: Replace XXX with flow rate using 3 digits, example 50 slpm = M050.

AP Tech has product options and variations which are not documented in data sheets. If you have a model number that is not defined by the ordering information, please consult the factory or your local representative.